

SECTION D

RAISED PANEL DOORS

RAISED PANEL DOORS

Application & Pricing

Tolerances

We warrant the outside dimensions of our doors to be within a size tolerance of plus or minus 1/32". All doors 24" wide by 48" high and smaller will have an allowable warpage tolerance of 1/8" and doors larger than this size will have a warpage tolerance of 1/4". Any door with a center panel wider than 24" will not be warranted from warpage. Doors over the height of 48" without an added mid rail will not be warranted from width warpage. All doors 72" and higher will not be warranted from warpage.

1" Thick Doors

Add 30% to the square foot price of the door.

Frame & Mullion Doors

Frame & Mullion Doors can be made from all of our standard door styles. The letter G (for Glass) will follow your door style designation as shown in the example below. When ordering, please use the raised panel door style designation and write in the Specifications box on the order form as follows:

Example: Style 1000G Frame Only or 6-Lite Mullion

Non Standard Parts

Our standard stile & rail width is 2-1/4". An additional \$2.50 will be added for each stile or rail that is increased or decreased from the standard width of 2-1/4". However, if an entire order is placed, for example, with all 3" stile & rails, there is no additional charge for non-standard parts. Likewise, if an order is placed using 2-1/4" stiles and 3" rails, there is no additional charge for non-standard parts.

Grain Direction

All stile & rail doors come standard with Vertical Grain. Grain direction can be changed to Horizontal Grain at no extra charge by noting it in either the Custom Details box or the Specifications box on the order form.

Minimum and Maximum Sizes

All doors carry a 1 square foot minimum charge. The minimum size of each style of door is listed below each door image. The total square foot of the door is calculated by rounding up to the nearest inch. Any door exceeding 48" in height will require a mid rail or will not be warranted from width warpage.

Grain Matched Panels

Grain Matched Panels are standard on all doors that have two vertical panels, (a top & bottom panel) with a maximum height of 64". Doors over 64" will not have Grain Matched Panels unless otherwise requested. Add \$25.00 per Grain Matched Panel for doors over 64" in height.

Oversized Doors

Any door 8 square feet and up to 12 square feet will be considered an Oversized Door +8 (D/O+8) and \$2.50 will be added to the square foot price of the door. Any door over 12 square feet will be considered an Oversized Door +12 (D/O+12) and \$5.00 will be added to the square foot price of the door. Pricing for both includes Non Standard Parts.

RAISED PANEL DOORS

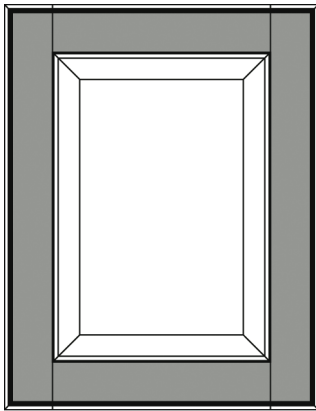

Style 1000

Min. Size: 8 x 8
Price Column: 1
Frame Column: 17

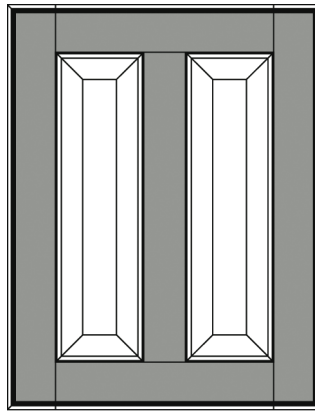

Style 1010

Min. Size: 14 x 8
Price Column: 3
Frame Column: 19

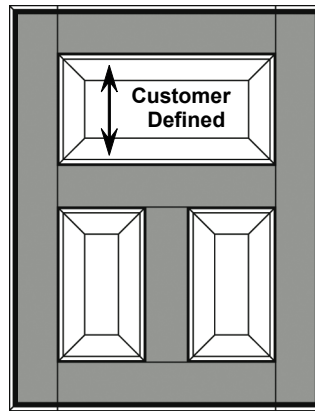

Style 1030

Min. Size: 14 x 16
Price Column: 5
Frame Column: 21

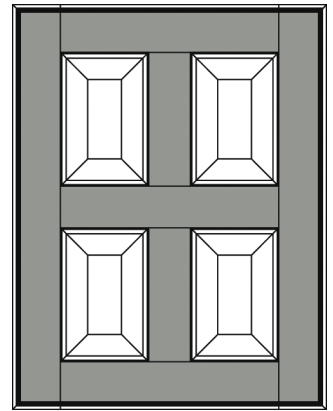

Style 1040

Min. Size: 14 x 16
Price Column: 7
Frame Column: 22

Grain Matched Panels - Mid Rail Placement

The arrows below indicate grain matched panels which is standard on doors up to 64" in height.

Mid rail placement can be specified at no additional charge (Customer Defined-CD).

Example: The door style designation for a Customer Defined mid rail placement is a **Style 1050-CD**.

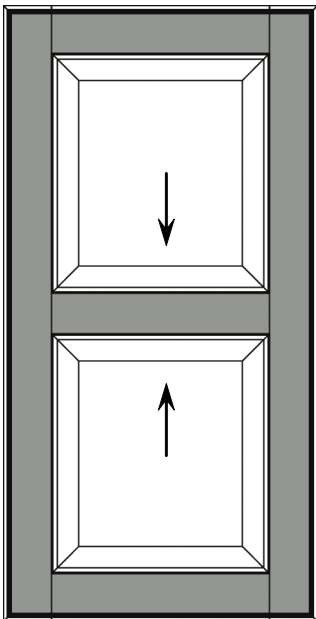

Style 1050

Min. Size: 8 x 16
50/50 Split
Price Column: 3
Frame Column: 19

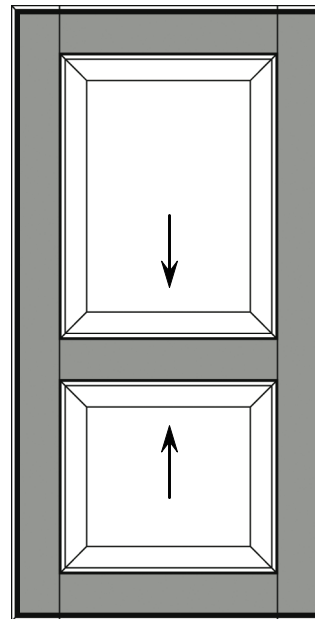

Style 1064

Min. Size: 8 x 18
60/40 Split
Price Column: 3
Frame Column: 19

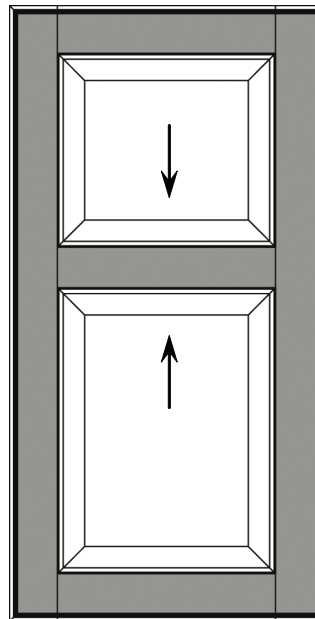

Style 1046

Min. Size: 8 x 18
40/60 Split
Price Column: 3
Frame Column: 19

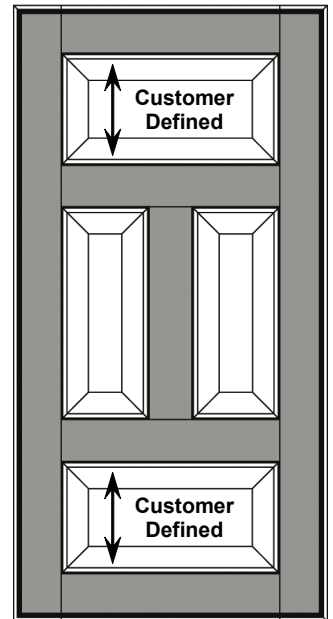

Style 1080

Min. Size: 14 x 24
25/50/25 Split
Price Column: 7
Frame Column: 22

RAISED PANEL DOORS

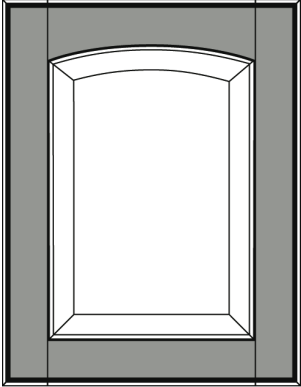

Style 2000

Min. Size: 9 x 10
Price Column: 2
Frame Column: 18

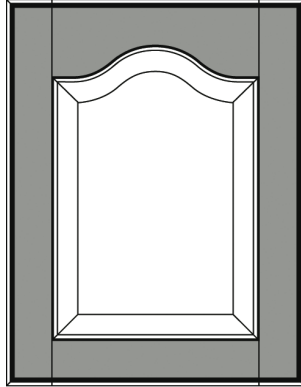

Style 3000

Min. Size: 9 x 10
Price Column: 2
Frame Column: 18

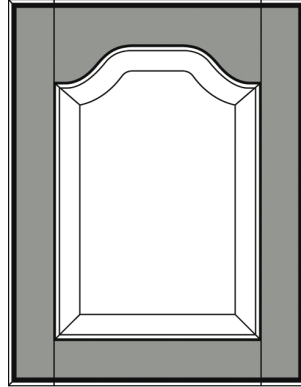

Style 4000

Min. Size: 13 x 10
Price Column: 2
Frame Column: 18

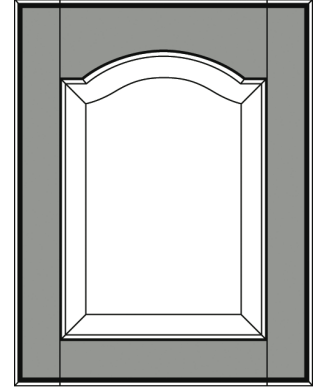

Style 5000

Min. Size: 9 x 10
Price Column: 2
Frame Column: 18

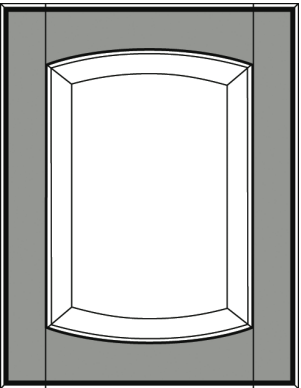

Style 2055

Min. Size: 9 x 12
Price Column: 4
Frame Column: 20

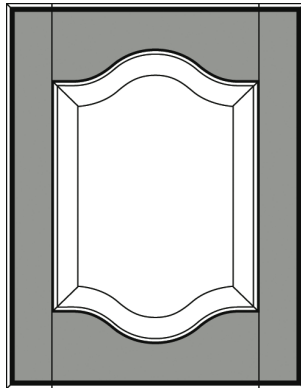

Style 3055

Min. Size: 9 x 12
Price Column: 4
Frame Column: 20

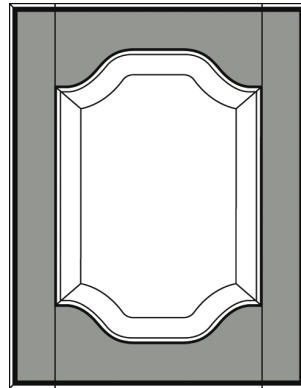

Style 4055

Min. Size: 13 x 12
Price Column: 4
Frame Column: 20

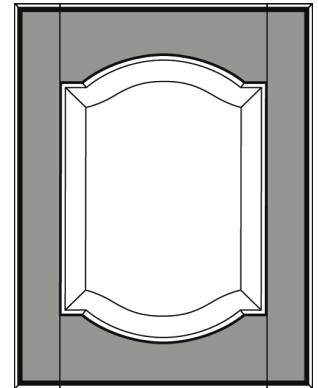

Style 5055

Min. Size: 9 x 12
Price Column: 4
Frame Column: 20

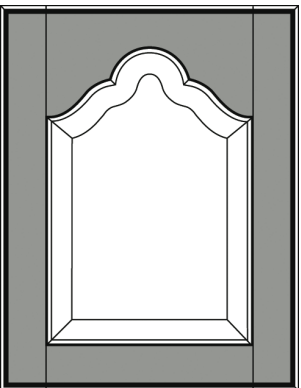

Style 6000

Min. Size: 13 x 12
Price Column: 4
Frame Column: 20

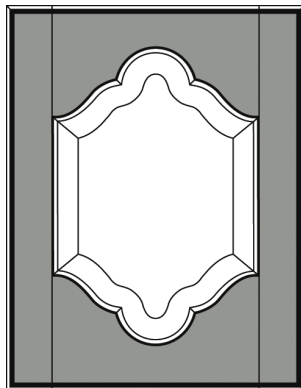

Style 6055

Min. Size: 13 x 18
Price Column: 6
Frame Column: 21

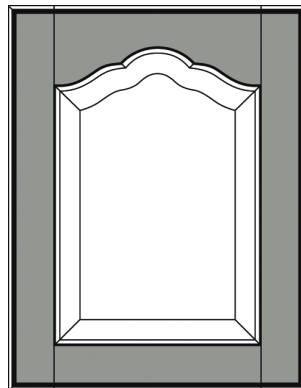

Style 7000

Min. Size: 13 x 10
Price Column: 3
Frame Column: 20

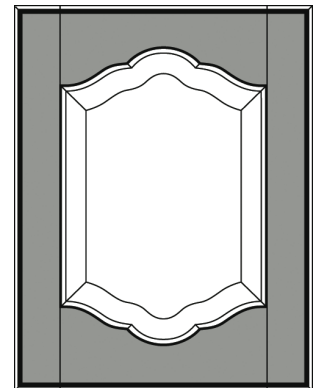

Style 7055

Min. Size: 13 x 12
Price Column: 5
Frame Column: 21

RAISED PANEL DOORS

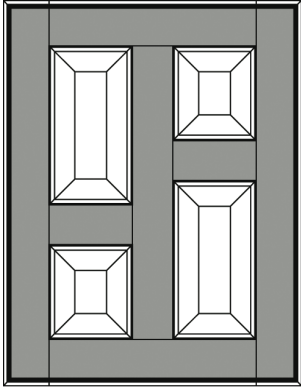

Style 1060 L

Min. Size: 14 x 16
Price Column: 7
Frame Column: 22

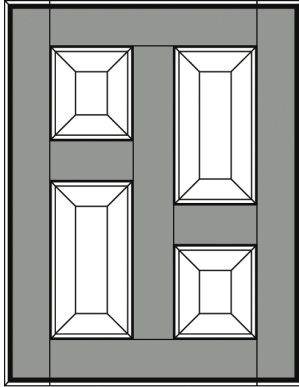

Style 1060 R

Min. Size: 14 x 16
Price Column: 7
Frame Column: 22

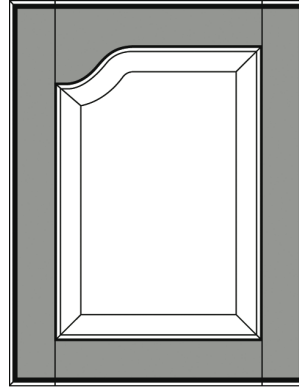

Style 44 L

Min. Size: 9 x 10
Price Column: 2
Frame Column: 18

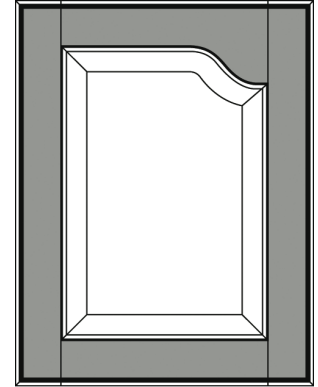

Style 44 R

Min. Size: 9 x 10
Price Column: 2
Frame Column: 18

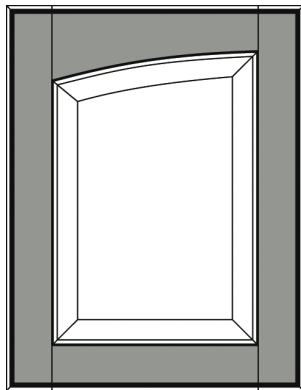

Style 22 L

Min. Size: 9 x 10
Price Column: 2
Frame Column: 18

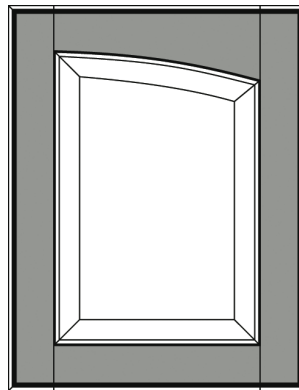

Style 22 R

Min. Size: 9 x 10
Price Column: 2
Frame Column: 18

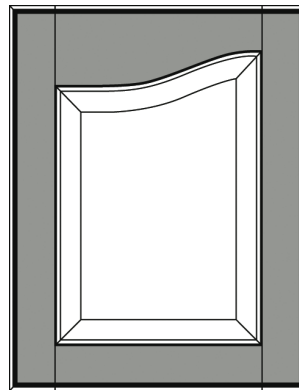

Style 33 L

Min. Size: 10 x 12
Price Column: 2
Frame Column: 18

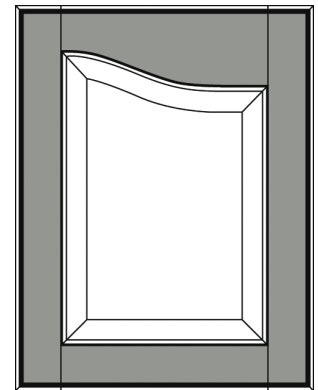

Style 33 R

Min. Size: 10 x 12
Price Column: 2
Frame Column: 18

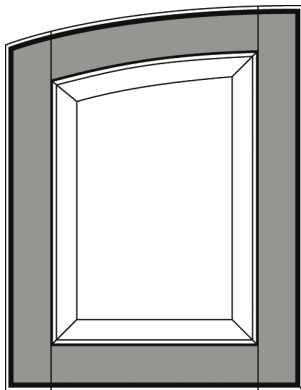

Style 222 L

Min. Size: 9 x 10
Price Column: 8
Frame Column: 22

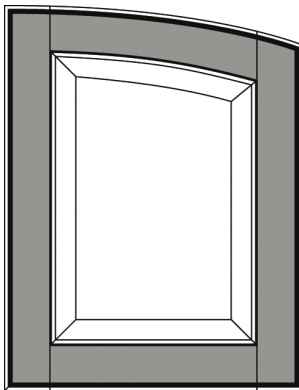

Style 222 R

Min. Size: 9 x 10
Price Column: 8
Frame Column: 22

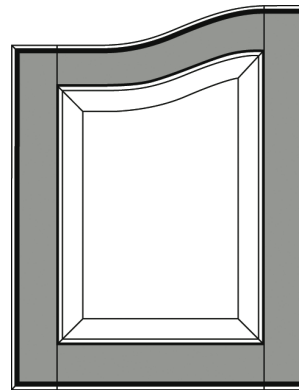

Style 333 L

Min. Size: 10 x 12
Price Column: 8
Frame Column: 22

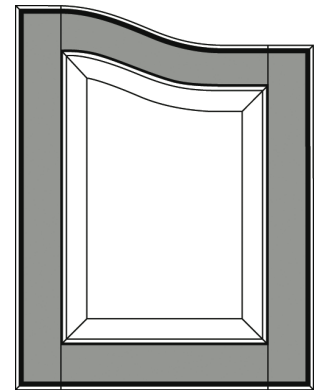

Style 333 R

Min. Size: 10 x 12
Price Column: 8
Frame Column: 22

RAISED PANEL DOORS

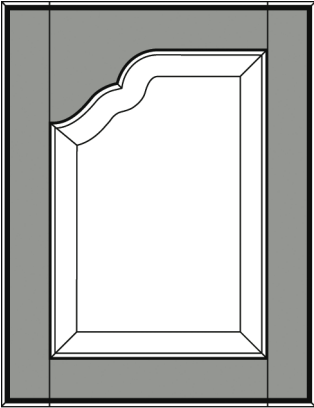

Style 60 L

Min. Size: 12 x 12
Price Column: 4
Frame Column: 20

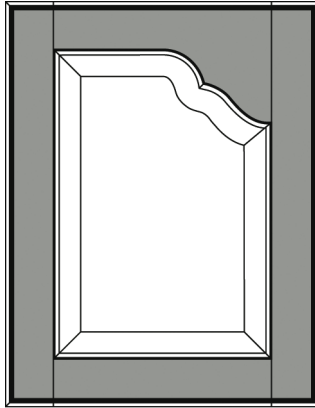

Style 60 R

Min. Size: 12 x 12
Price Column: 4
Frame Column: 20

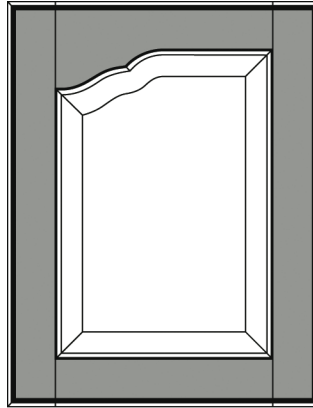

Style 70 L

Min. Size: 10 x 10
Price Column: 3
Frame Column: 20

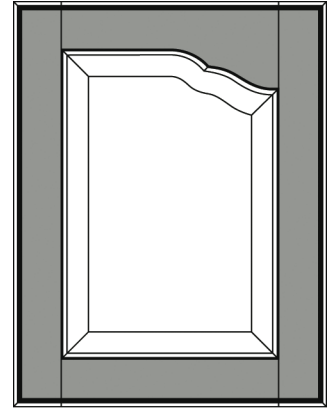

Style 70 R

Min. Size: 10 x 10
Price Column: 3
Frame Column: 20

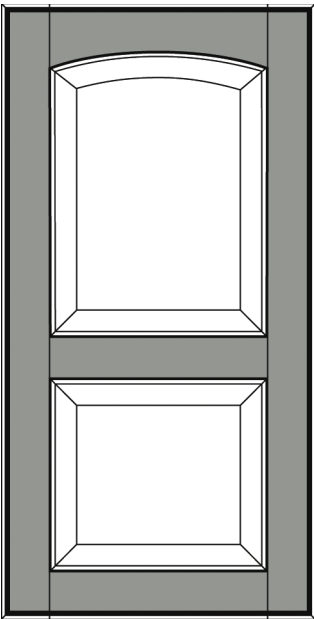

Style 2064

60/40 Split
or

Style 2050

50/50 Split

Min. Size: 9 x 16
Price Column: 4
Frame Column: 20

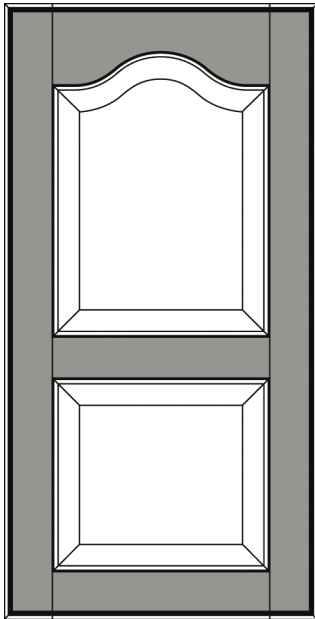

Style 3064

60/40 Split
or

Style 3050

50/50 Split

Min. Size: 9 x 16
Price Column: 4
Frame Column: 20

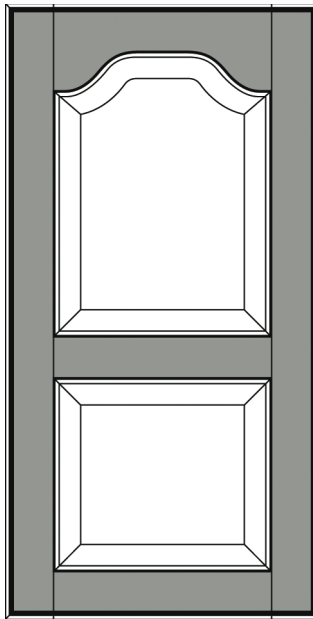

Style 4064

60/40 Split
or

Style 4050

50/50 Split

Min. Size: 13 x 16
Price Column: 4
Frame Column: 20

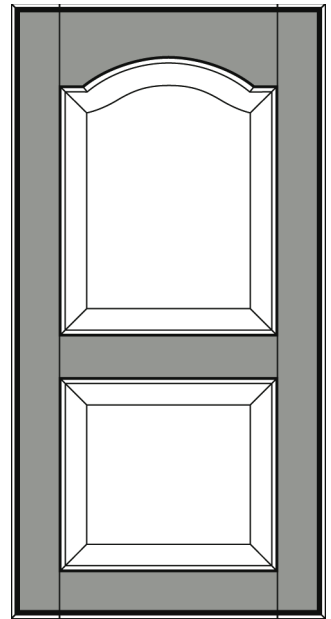

Style 5064

60/40 Split
or

Style 5050

50/50 Split

Min. Size: 9 x 16
Price Column: 4
Frame Column: 20

RAISED PANEL DOORS

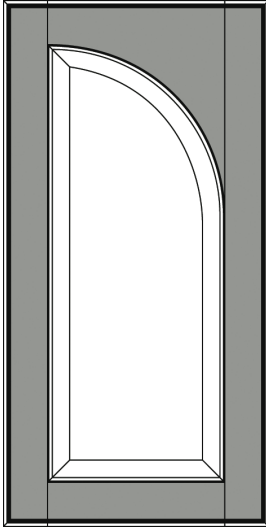
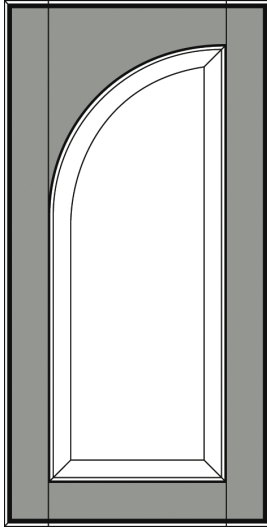

Style 105 L

Style 105 R

Quarter Circle

Min. Size: 14 x 16

Price Column: 34 Frame Column: 23

Veneer Panel

Price Column: 33

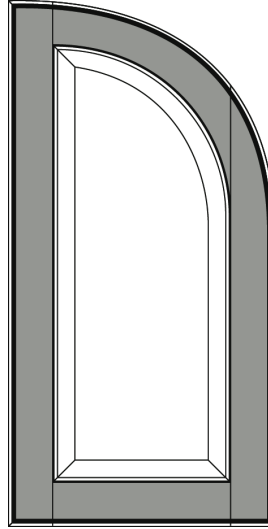
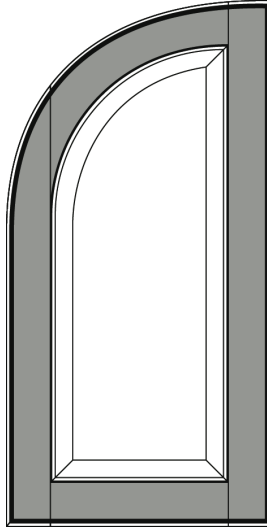

Style 605 L

Style 605 R

Quarter Circle

Min. Size: 14 x 16

Price Column: 34 Frame Column: 23

Veneer Panel

Price Column: 33

Add \$1.75 per sq. ft. for top arch radius

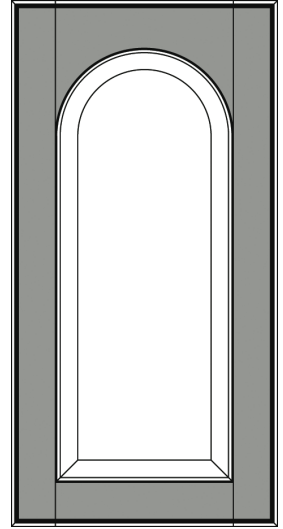

Style 405

Full Half Circle

Min. Size: 14 x 14

Price Column: 34

Frame Column: 23

Veneer Panel

Price Column: 33

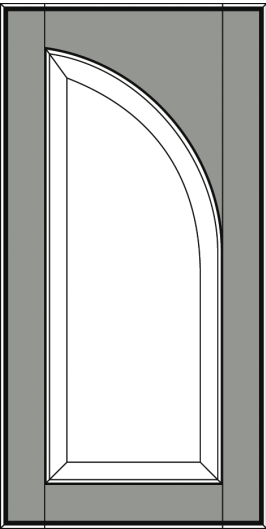
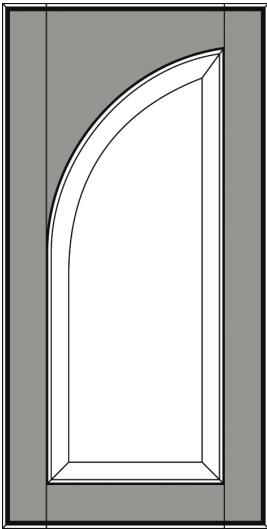

Style 205 L

Style 205 R

Half Circle

Min. Size: 14 x 16

Price Column: 34 Frame Column: 23

Veneer Panel

Price Column: 33

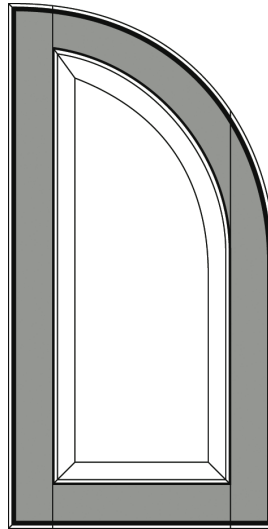
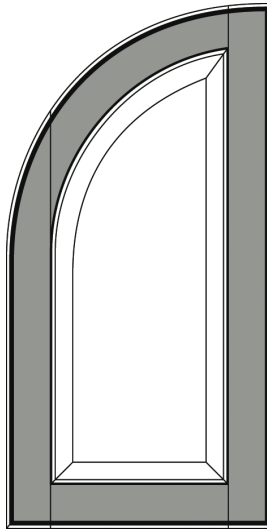

Style 305 L

Style 305 R

Half Circle

Min. Size: 14 x 16

Price Column: 34 Frame Column: 23

Veneer Panel

Price Column: 33

Add \$1.75 per sq. ft. for top arch radius

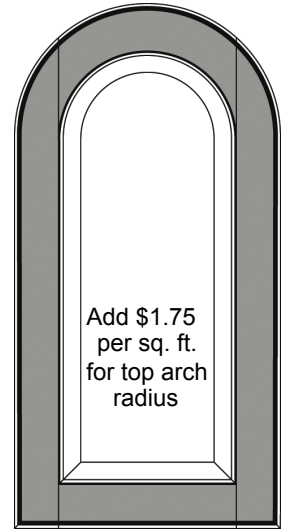

Style 505

Full Half Circle

Min. Size: 14 x 14

Price Column: 34

Frame Column: 23

Veneer Panel

Price Column: 33

Add \$1.75
per sq. ft.
for top arch
radius

RAISED PANEL DOORS

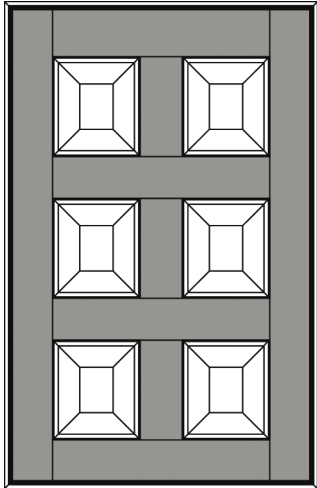

Style 1000 M-PNL

Custom Multiple Raised Panel Door
 This designation and pricing will be used for custom doors with multiple panels and custom configurations as per your specs that are not found in our standard door selection.

Price Column: 7
 Frame Column: 22

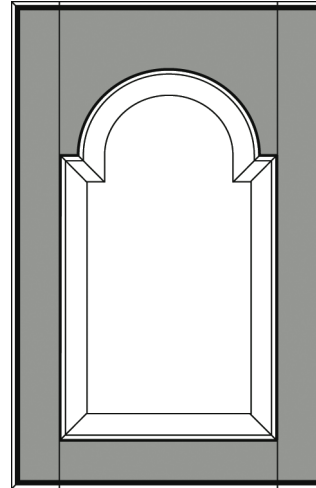

Style 805 CA

Custom Arched Raised Panel Door
 This designation and pricing will be used for doors with a custom arch as per your specs that are not found in our standard arched door selection. Design charges may be added.

Price Column: 34
 Frame Column: 23

SLAB DOORS

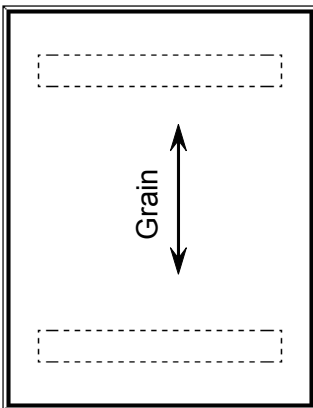

Style 8000

Slab Door with Battens
 Vertical Grain
 Price Column: 1

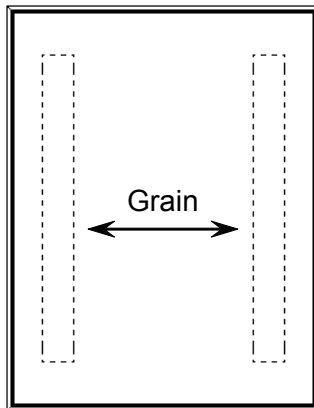

Style 8000 H

Slab Door with Battens
 Horizontal Grain
 Price Column: 1

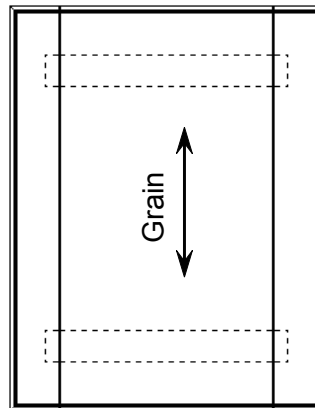

Style 802S

Slab Door
 With Attached Stiles
 Vertical Grain
 Price Column: 3

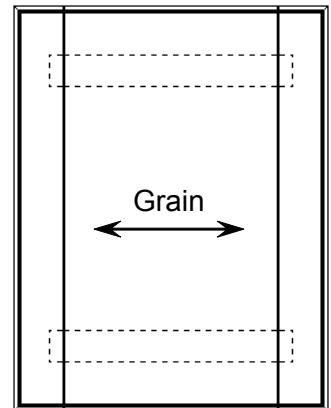

Style 802S H

Slab Door
 With Attached Stiles
 Horizontal Grain
 Price Column: 3

HINGE BORING

Application & Pricing

35mm Hinge Boring Options

Three Hinge Boring Patterns are available for 35mm concealed hinges.

All holes are drilled 1/2" deep. See drawing for details below.

HBP 1 Single 35mm bore.

HBP 2 Blum/Salice boring pattern for hinges with dowels. Fits most Blum/Salice hinges.

HBP 3 Grass boring pattern for hinges with dowels. Fits most Grass hinges.

When ordering, please indicate on the order form the following:

- 1). Indicate Hinged Left (L) or Hinged Right (R) in the hinge bore column on the order form. Which side the door is hinged (L or R) is determined from looking at the front side of the door.
- 2). Distance from the outside edge of the door (DE) to the edge of the 35mm bore-typically 1/8" (5mm).
- 3). Distance from the top and bottom edge of the door (DT) to the center of the 35mm bore.

Please Note:

Hinge bore patterns cannot be drilled on doors with less than a 1-3/4" wide stile or rail.

Hinge bore patterns cannot be drilled on glass frame doors with less than a 2" wide stile or rail.

Pricing: Add \$2.25 per each hinge bore.

